

ACCULINETM

LASER LEVELS

PROTM

Multi-Beam Self-Leveling Line Generator **Model No. 40-6660**

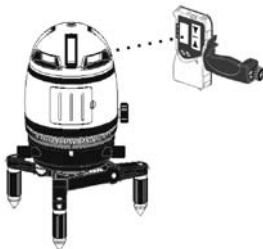

Instruction Manual

Congratulations on your choice of this Multi-Beam Self-Leveling Line Generator. We suggest you read this instruction manual thoroughly before using the instrument. Save this instruction manual for future use.

This tool emits five laser beams and one down plumb beam which projects a series of visible points on surfaces around the product (i.e. left, right, front, up, and down). Beam visibility depends upon lighting conditions in the work area.

This is a Class II laser tool and is manufactured to comply with CFR 21, parts 1040 .10 and 1040 .11 as well as international safety rule IEC 285.

Table of Contents

- | | |
|--|--------------------------------|
| 1. Kit Contents | 8. Self-Check and Calibration |
| 2. Features and Functions | 9. Technical Specifications |
| 3. Safety Instructions | 10. Application Demonstrations |
| 4. Location/Content
of Warning Labels | 11. Care and Handling |
| 5. Location of Parts/Components | 12. Product Warranty |
| 6. Operating Instructions | 13. Product Registration |
| 7. Using the Accessories | 14. Accessories |

1. Kit Contents

Description	Qty.
Multi-Beam Self-Leveling Line Generator	1
Base	1
Ni-MH Rechargeable Battery Pack	2
5/8" –11 Tripod Adapter	1
Spanner Wrench for Tripod Adapter	1
Battery Adapter	1
Detector with Clamp and 9V Battery	1
Tinted Glasses	1
Magnetic Target	1
Instruction Manual with Warranty Card	1
Hard Shell Carrying Case	1

2. Features and Functions

- Switchable between continuous laser state and pulse laser beam (for use with detector)
- Able to project four laser cross lines and one laser point (and a down plumb)
- Self-leveling compensation system.
- Laser flashes and sounds audible alarm when product beyond leveling range.
- Able to individually project one horizontal line, or three vertical lines that are perpendicular to each other, with one red plumb-down point.
- Able to simultaneously emit three cross lines in right angle, and one plumb beam formed by cross intersection on ceiling, and plumb-down point.
- The top vial can help to ensure higher accuracy.
- Able to freely rotate by 360 degrees, and allows for fine angle adjustment.
- Unique base is foldable, and its legs are adjustable in length.
- Plumb-down point can be shift and centered.
- Magnetic dampening compensation system.
- Can be connected with tripod through 5/8" screw fittings.
- The included laser detector provides added functionality by allowing use of the unit (in pulse setting) outdoors or in bright surroundings where beams are not visible.

3. Safety Instructions

Please read and understand all of the following instructions, prior to using this tool. Failure to do so, may result in bodily injury.

CAUTION!

Class II Laser Product
Max. Power Output: $\leq 1\text{mW}$
Wavelength: 625-645nm

**THIS TOOL EMITS LASER RADIATION.
DO NOT STARE INTO BEAM.
AVOID DIRECT EYE EXPOSURE.**

**ATTENTION****IMPORTANT**

- Read all instructions prior to operating this laser tool. Do not remove any labels from tool.
- Use of controls or performance of procedures other than those specified herein may result in hazardous radiation exposure.
- Do not stare directly at the laser beam.
- Do not project the laser beam directly into the eyes of others.
- Do not set up laser tool at eye level or operate the tool near a reflective surface as the laser beam could be projected into your eyes or into the eyes of others.
- Do not place the laser tool in a manner that may cause someone to unintentionally look into the laser beam. Serious eye injury may result.
- Do not operate the tool in explosive environments, i.e. in the presence of gases or flammable liquids.
- Keep the laser tool out of the reach of children and other untrained persons.
- Do not attempt to view the laser beam through optical tools such as telescopes as serious eye injury may result.
- Always turn the laser tool off when not in use or left unattended for a period of time.
- Remove the batteries when storing the tool for an extended time (more than 3 months) to avoid damage to the tool should the batteries deteriorate.
- Do not attempt to repair or disassemble the laser tool. If unqualified persons attempt to repair this tool, serious injury may result.
- Use only original AccuLine Pro™ parts and accessories purchased from your AccuLine Pro authorized dealer. Use of non-AccuLine Pro parts and accessories will void warranty.

CAUTION: If using this product with any type of tinted goggles, please note safety warning below.

WARNING!

The tinted goggles are designed to enhance the visibility of the laser beam. They DO NOT offer protection to the eyes from direct exposure of the laser beam.



4. Location/Content of Warning Labels



CAUTION

Laser Radiation. Do Not Stare Into Beam.

Maximum Output Power = 1mW
 Wavelength = 635-645nm
 Class II Laser Product
 Complies with applicable requirements
 of 21CFR parts 1040.10 and 1040.11.

Mfg. for Johnson Level & Tool Mfg. Co., Inc.
 6333 W. Douglas Bay Rd., Mequon, WI 53092
 Manufactured in China by JLT05
 Date (m/y): _____



Laser radiation is emitted from these 2 apertures

AVOID EXPOSURE

5. Location of Part/Components

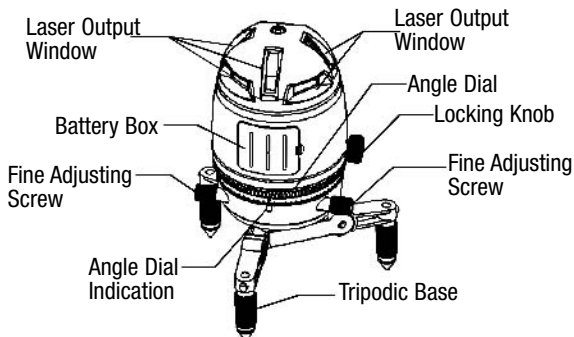

Fig. 1

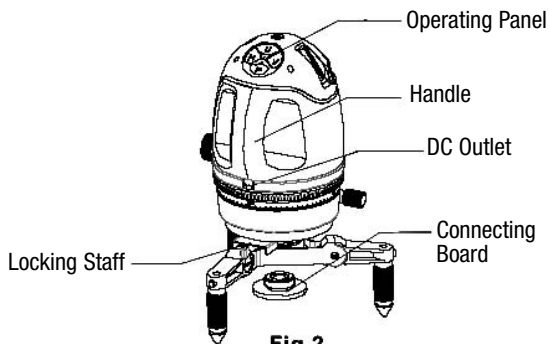

Fig. 2

6. Operating Instructions

IMPORTANT: It is the responsibility of the user to verify the calibration of the instrument before each use.

Battery Installation

Note: Always check to be sure that the on/off switch is in the off position before removing and replacing batteries.

1. Open the battery box and put in rechargeable battery pack. Please pay attention to polarity.
2. Indicator lamp blinking means low voltage. Charge the rechargeable battery pack before initial use.

Note:

- As for the initial two times charge of new battery pack, it is necessary to charge for 12-plus hours.
- Do not charge alkaline batteries to avoid explosion.
- Used (discharged) batteries are hazardous waste and should be disposed of properly.

DC Outlet

1. Connect adapter (included) to the outlet.
2. You don't need to take out the battery pack when using the adapter.

Power-On

1. By setting the locking knob to UNLOCK position, the self-leveling system is released, and simultaneously the instrument is powered on.



2. Activate the horizontal line H, vertical lines V1 and V2, and plumb-down point by pressing the corresponding keys on the operating panel (Fig. 3).

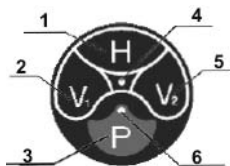

Fig. 3

1. Horizontal Line H Button
2. Vertical Line V1 Button
3. Modulation Switching P Button
4. Power Indicator Lamp
5. Vertical Line V2 Button
6. Modulation Switching Indicator Lamp

3. When the power indicator lamp is lit, this means the laser is turned on. When the blinking power indicator lamp is lit, this means low battery voltage.
4. If the instrument is set up on a slope beyond the self-leveling range, the laser will flash and with an audible sound at the same time. Users should reset up the instrument to a more level position (with the aid of the vial on top).
5. When the horizontal line H, vertical line V1 and V2 are all lit, these three laser lines form four cross intersections. Among them, the top intersection is the plumb-up point of the unit, which constitutes plumb beam together with the plumb-down point. Three intersections on the horizontal line is the horizontal cross lines perpendicular to each other (Fig. 4).

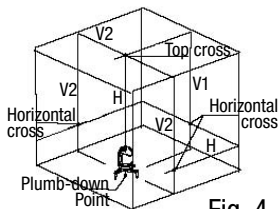

Fig. 4

6. Adjust the screws on the three legs of the base to center the top bubble, which will achieve the higher accuracy (Fig. 5).

Power-Off

Set the locking knob to LOCK position, and the instrument is powered off (Fig. 6).

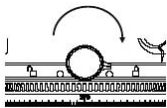

Fig. 6

Locking Position

Note: The locking knob must be set to LOCK position when the user needs to move the instrument or packed into the case. If the alarms sounds when you move the unit, it means the locking screw is not locked. Please make sure to lock it.

Center Position Adjusting

Push the locking staff leftwards, and then the instrument can be moved to different directions freely in order to have plumb-down laser point accurately coincide with the reference mark on floor. Push the locking staff rightwards, and then you can't move the instrument any more (Fig. 7).

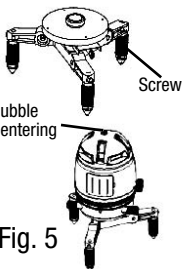

Fig. 5

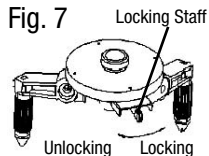

Fig. 7

Laser Output Position Adjusting

Rotate the instrument to the desired position, and then adjust the two fine adjusting screws for precise angle adjustment (Fig. 8).

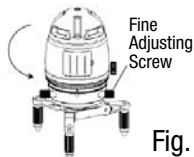

Fig. 8

Angle Dial

The angle dial is helpful when users need to set the instrument to a desired angle. Have the vertical lines aim at an object, and then rotate the angle dial to make the zero scale coincide with the angle dial scale.

Then adjust the instrument to the desired angle according to the method described in Laser Output Position Adjusting (Fig. 8, Fig. 9).

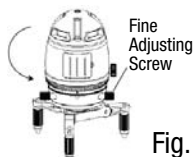

Fig. 8

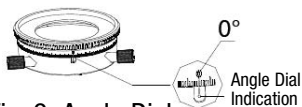
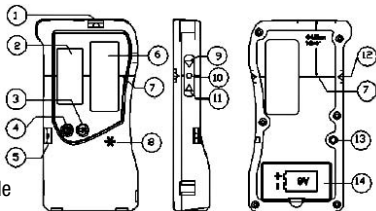

Fig. 9 Angle Dial

7. Using the Accessories

Laser Detector Usage

With the laser detector included, the instrument can be used both indoors with bright light and/or outdoors in the sunlight where beams are not visible.



1. Horizontal Indicating Bubble
2. Detecting Window
3. Sound Option Key
4. Power On/Off Key
5. Vertical Indicating Bubble
6. LCD
7. 0 Scale
8. Buzzer

9. Upper Indicator Lamp
10. Middle Indicator Lamp
11. Lower Indicator Lamp
12. Lineation Groove
13. Set Screw
14. Battery Door

LCD Indicating Note

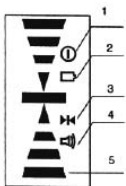

1. Power
2. Low Voltage
3. Detection
4. Sound
5. Detected Position

Operation Instruction

1. Battery Installation

Open the battery door, and put in one 9V battery according to the polarity shown inside. Then snap the battery door back.

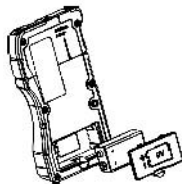

Note:

- Take the battery out when the unit is not in use for a long time.
- Replace the battery when indicator shows low battery.
- Used (discharged) batteries are hazardous waste and should be disposed of properly

2. Detection

(Important: The detector will only work in pulse mode)

Note: Keep the unit stable during detection.

- A. One press on Power on/off key will show all signs on LCD, and 0.5 second later the detector enters detecting status, with only Power-on and detection signs shown on LCD.

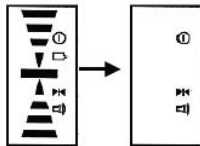

- B. Detecting the horizontal laser signal:
Put the detector in a vertical position (observe the horizontal indicating bubble) with the detecting window facing the unit to receive the laser signal. A downward arrow shown on LCD plus a lit red lamp means the laser signal is below the detector. An Upward arrow plus a yellow lit lamp means the laser signal is above the detector. A middle sign plus a lit green lamp means the laser signal is centered.

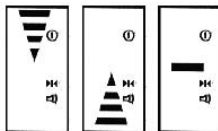

Note: When the laser signal moves towards the center position, the displayed upward or downward arrows will decrease segment by segment along the direction towards the middle, until the centered single line appears.

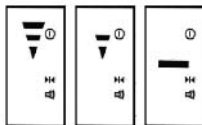

- C. Detecting the vertical laser signal. Put the detector in a horizontal position (observe the vertical indicating bubble) with the face including an indicator lamp upwards. Have the detecting window face the unit to receive the vertical laser signal. Leftward arrow shown on LCD plus a lit red lamp means the laser signal is on the left side. A v-centered sign with a lit green lamp means the laser signal is on the middle position. A rightward arrow plus a lit yellow lamp means the laser signal is on the right side.

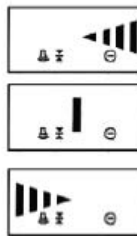

- D. Press the Power on/off key in the power-on state, and the detector will be powered off.

3. Sound Function

Pressing the sound key under power-on status will switch the unit between sound status and silent status, with the sound sign indication on LCD.

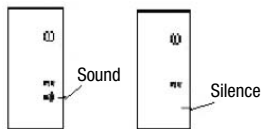

Under the status with sound function on:

- If the laser signal is on the top (left) side, then the detector will give single short alarm.
- If the laser signal is on the bottom (right) side, then the detector will give double short alarm.
- If the laser signal is on the middle, then the detector will keep long alarm.

Note: Whether under sound or silent status, the keys always keep cue sound.

4. Power Save Function

When receiving no laser signal and no operation against keys for six continuous minutes, the unit will power off automatically to preserve battery life.

5. Low Battery Indicator Function

- When the power indicator sign is blinking, this means that the battery is low and should be replaced.
- Seriously low battery will result in automatic power-off, which requires the user to immediately replace before more operation.

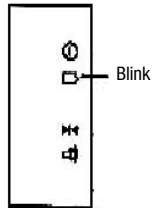

Technical Specifications

Detecting Distance	≥164 ft (50m) 0 ≥98 ft (30m) 45
Detecting Frequency	8KHz-12KHz
Detecting Accuracy	0.019" ≤ 49 ft. (0.5mm ≤15m) 0.039" ≤ 114 ft. (1mm ≤35m) 0.059" ≥ 114 ft. (1.5mm ≥35m)
Timed Power-off	6 minutes
Working Voltage	DC 9V
Sound Function:	Single short alarm double short alarm long alarm
LCD	Upward arrow downward arrow centered sign
LED Indication	Up, middle, down
Size	5.905" x 2.992" x 1.142" (150 x 76 x 29mm)
Weight	0.386 lb. (175g)
Dust and rain resistant	

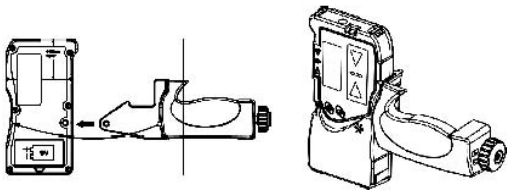

Instrument Usage

Tripod Usage

The instrument can be used either directly on floor or on tripod. If operating with tripod, users should first screw the connecting board into the thread on the instrument bottom, and set it up on tripod

Tripodic Base Usage

1. Connect the instrument with tripodic base through 5/8" center thread, and then the plumb-down point function become available for use.
2. Tripodic base can be folded used.
3. The legs could be adjusted in length

Laser Glasses Usage

1. Glasses are adjustable in leg length.
2. Red glasses can enhance the visibility laser beam. Glasses do not offer protection to the eyes from direct exposure of the laser beam.

Laser Target Usage

1. The magnet on target can conveniently attached to metal objects.
2. Target can also be hung on wall or pillar.
3. Target can greatly increase the brightness of the observed laser beam.

8. Self-Check and Calibration

Horizontal Laser Line Accuracy Self-Check

1. Find a wall and set up the instrument at 16 ft. (5m) away from the wall.
2. Unlock the instrument and switch on the laser line H, V1, V2 by pressing the button H, V1, V2.
3. Rotate the instrument horizontally to have V1 face against the wall, and mark its intersection with H as point A (Fig. 11-1).
4. Turn the instrument to have V2 coincide with point A.
5. Measure the distance e between H and point A.
6. If $e > 0.079"$ (2mm), the horizontal accuracy is beyond tolerance (Fig. 11-2).

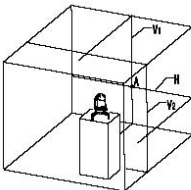

Fig. 11-1

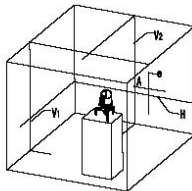

Fig. 11-2

Vertical Laser Line Accuracy Self-Check

1. Find a wall and set up the unit at 16 ft. (5m) away from the wall.
2. Unlock the instrument and switch on the laser line V1 by pressing the button V1.
3. Rotate the instrument horizontally to have V1 face against the wall.
4. Hang up a plummet at the position of V1 as standard plumb line, which is 9 ft. (3m) long and as close to the floor as possible.
5. Turn the fine adjusting knob to have the upside of V1 coincide with the standard plumb line.

6. Observe whether the downside of V1 coincides with the standard plumb line or not. If not, and the deviation exceeds 0.039" (1mm), then V1 line's vertical accuracy e is beyond tolerance (Fig.12).

NOTE: During the observation, make sure that your viewing is against the laser line and the standard plumb line.

7. Follow the same method to check the accuracy of V2.
8. If the self-checked accuracy is beyond tolerance, reference section 12 of this document.

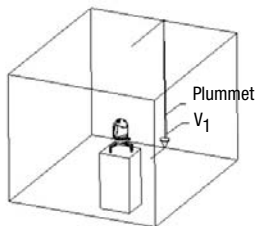

9. Technical Specifications

Laser Wavelength	635nm±10nm
Laser Classification	II
Maximum Power Output	≤1mW
Accuracy	±3/8"/100 ft. (±3mm/10m)
Working Range	Maximum 100 ft. (30m) depending upon light conditions
Measuring Range	131 ft. (40m) radius with detector
Self-leveling Range	±3.5° with laser flashing and sound alarm when out of tolerance
Power Supply	Rechargeable battery pack or battery adapter
Dimensions	5-1/2" x 5" x 7" (140 x 125 x 180mm)
Weight	9.39 lbs (4.25 Kg)
Working Temperature	14°F to 113°F (-10°C to +40° C)
Center Screw Thread	5/8" – 11; 1/4" –20

10. Application Demonstrations

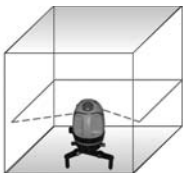

Supply one super-long horizontal line

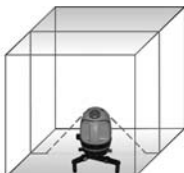

Supply one super-long vertical line on ceiling



Supply 1 front vertical and 1 plumb point

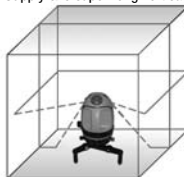

Supply 2 laser cross lines on right and left sides, respectively

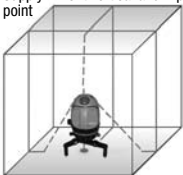

Supply plumb reference formed by the laser cross line on ceiling and plumb down point

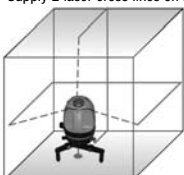

Supply one front laser cross line

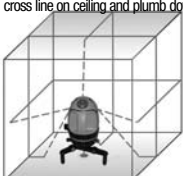

Simultaneously supply four laser crosslines on the front, left, right, and top



Operate with one detector to extend working distance

11. Care and Handling

- This laser unit is a precision tool that must be handled with care.
- Avoid exposing unit to shock vibrations and extreme temperatures.
- Before moving or transporting the unit, make sure that the unit is turned off and in the locked position. Failure to lock before transport or storage may cause damage to the units inner mechanism and void warranty.
- Remove the batteries when storing the unit for an extended time (more than three months) to avoid damage to the unit should the batteries deteriorate.
- Always store the unit in its case when not in use.
- Avoid getting the unit wet.
- Keep the laser unit dry and clean, especially the laser output window. Remove any moisture or dirt with a soft, dry cloth.
- Do not use harsh chemicals, strong detergents or cleaning solvents to clean the laser unit.

12. Product Warranty

Johnson Level & Tool offers a one year limited warranty on each its products. You can obtain a copy of the limited warranty for a Johnson Level & Tool product by contacting Johnson Level & Tool's Customer Service Department as provided below or by visiting us online at www.johnsonlevel.com. The limited warranty for each product contains various limitations and exclusions.

Do not return this product to the store/retailer or place of purchase. Required repair/calibration must be done by an authorized AccuLine Pro™ service center or Johnson Level & Tool's limited warranty, if applicable, will be void and there will be NO WARRANTY. Contact our Customer Service Department to obtain a Return Material

Authorization (RMA) number for return to an authorized service center.
Proof of purchase is required.

NOTE: The user is responsible for the proper use and care of the product.

It is the responsibility of the user to verify the calibration of the instrument before each use.

For further assistance, or if you experience problems with this product that are not addressed in this instruction manual, please contact our Customer Service Department.

In the U.S., contact Johnson Level & Tool's Customer Service Department at 800-563-8553.

In Canada, contact Johnson Level & Tool's Customer Service Department at 800-346-6682.

13. Product Registration

Enclosed with this instruction manual you will find a warranty card to be completed for product warranty registration. Product warranty registration can also be completed online at our web site www.johnsonlevel.com. You will need to locate the serial number for your product that is located on the bottom of the unit. **PLEASE NOTE THAT IN ADDITION TO ANY OTHER LIMITATIONS OR CONDITIONS OF JOHNSON LEVEL & TOOL'S LIMITED WARRANTY, JOHNSON LEVEL & TOOL MUST HAVE RECEIVED YOUR PROPERLY COMPLETED WARRANTY CARD WITHIN 30 DAYS OF YOUR PURCHASE OF THE PRODUCT OR ANY LIMITED WARRANTY THAT MAY APPLY SHALL NOT APPLY AND THERE SHALL BE NO WARRANTY.**

14. Accessories

AccuLine Pro™ accessories are available for purchase through authorized AccuLine Pro dealers. Use of non-AccuLine Pro accessories will void any applicable limited warranty and there will be **NO WARRANTY**. If you need any assistance in locating any accessories, please contact our Customer Service Department.

In the U.S., contact Johnson Level & Tool's Customer Service Department at 800-563-8553.

In Canada, contact Johnson Level & Tool's Customer Service Department at 800-346-6682.