



130' Laser Distance Meter w/Bluetooth®
Model No. LDM130



Instruction Manual

Congratulations on your choice of this Laser Distance Meter. We suggest you read this instruction manual thoroughly before using the instrument and save this instruction manual for future use.

This is a Class II laser tool and is manufactured to comply with CRF 21, parts 1040.10 and 1040.11 as well as international safety rule IEC 285. The laser also complies with EMC Test according to EN61000-6-3; 2001+A11:2004, EN 6100-6-1:2011, EN 6100-4-2, EN 61000-4-3, EN 60825, FCC Test according to PART 15.



Table of Contents

- | | |
|--|------------------------------|
| 1. Kit Contents | 8. Using the Bluetooth® App |
| 2. Features and Functions | 9. Tips from the Pros |
| 3. Safety Instructions | 10. Care and Handling |
| 4. Location/Content
of Warning Labels | 11. Troubleshooting Guide |
| 5. Location of Parts/Components | 12. Technical Specifications |
| 6. Battery Installation | 13. Product Warranty |
| 7. Operating Instructions | 14. Warranty Registration |
| | 15. Accessories |

1. Kit Contents

Description

Qty.

Laser Distance Meter	1
“AAA” Alkaline Batteries	2
Wrist Strap	1
Soft-Sided Pouch	1
Quick Start Guide	1





2. Features and Functions

- Four (4) measurement modes: Length (Single or Continuous), Area, Volume and 2-Point Pythagoras
- Displays in English or metric units with decimals or fractions (English units only)
- ISO 16331-1 tested* to typical accuracy of +/- 1/16" (0.0625", or 1.5mm)
- Bluetooth® enabled for syncing with the Johnson Measure-Up™ app (iOS or Android)
- High-speed microprocessor for quick, accurate calculations
- IP 54 protection – sealed from dust and rainwater

* This tool is tested in accordance with ISO 16331-1 "Laboratory procedures for testing surveying and construction instruments – Part 1: Performance of handheld laser distance meters." This standard is used to calculate accuracy under varying ambient lighting conditions. For more detailed test results, see the Technical Specifications section of this operator's manual.





3. Safety Instructions

Please read and understand all of the following instructions, prior to using this tool. Failure to do so, may void the warranty.

DANGER!

Class II Laser Product
Max. Power Output: $\leq 1\text{mW}$
Wavelength: 640-660nm

**THIS TOOL EMITS LASER RADIATION.
DO NOT STARE INTO BEAM.
AVOID DIRECT EYE EXPOSURE.**



ATTENTION



IMPORTANT

- Read all instructions prior to operating this laser tool. Do not remove any labels from tool.
- Do not stare directly at the laser beam.
- Do not project the laser beam directly into the eyes of others.
- Do not set up laser tool at eye level or operate the tool near a reflective surface as the laser beam could be projected into your eyes or into the eyes of others.
- Do not place the laser tool in a manner that may cause someone to unintentionally look into the laser beam. Serious eye injury may result.
- Do not operate the tool in explosive environments, i.e. in the presence of gases or flammable liquids.
- Keep the laser tool out of the reach of children and other untrained persons.
- Do not attempt to view the laser beam through optical tools such as telescopes as serious eye injury may result.
- Always turn the laser tool off when not in use or left unattended for a period of time.
- Remove the batteries when storing the tool for an extended time (more than 3 months) to avoid damage to the tool should the batteries deteriorate.
- Do not attempt to repair or disassemble the laser tool. If unqualified persons attempt to repair this tool, warranty will be void.
- Use only original Johnson® parts and accessories purchased from your Johnson® authorized dealer. Use of non-Johnson® parts and accessories will void warranty.



4. Location/Content of Warning Labels



Error Code Label

The LDM may return an error code during use, as indicated by the display showing “ERR X,” where “X” represents a number from 1 to 6.

The error codes are as follows:

1. **Laser Range** – The measurement distance is outside the range listed in the specifications.
2. **Weak Signal** – The reflected laser signal is too weak, either due to high ambient lighting at the target or poor target reflectivity.
3. **Display Range** – The measurement distance, area or volume exceeds the number of units the display is capable of showing.
4. **Low Battery** – The batteries need to be replaced.
5. **Temperature** – The tool is either above the maximum or below the minimum safe operating temperature range.
6. **Ambient Light** – The tool is being used in too bright of an environment to operate properly.

QR Code: Use a smartphone to scan the QR code to be taken directly to Johnson Level & Tool’s Operator’s Manual Page.

5. Location of Parts/Components

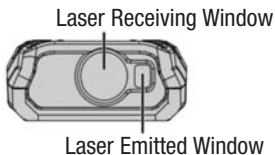
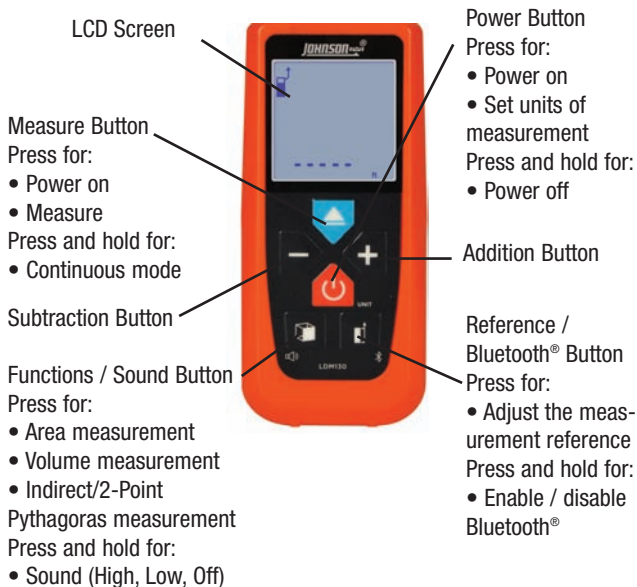



LCD Screen

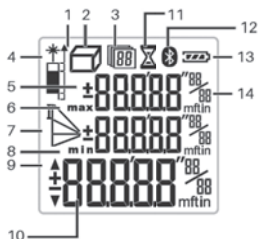

Not all features found on the LCD screen are found in every Johnson Level & Tool Laser Distance Meter. See the notes below for further information.

- | | |
|--|---|
| 1. Measurement Reference Position | 8. Minimum Display |
| 2. Measuring Mode | 9. Stake-out Direction Indicator† |
| 3. Memory (recent measurements)* | 10. Main Screen –
Current Measurement |
| 4. Active Laser Indicator | 11. Countdown Timer* |
| 5. Add and Subtract‡ | 12. Bluetooth® IndicatorΔ |
| 6. Maximum Display | 13. Battery Status Indicator |
| 7. Indirect Measuring Mode
(Pythagoras Measurements)‡ | 14. Secondary Screens
(prior 2 measurements) |

Notes:

* Feature available in the LDM330 only.

† Feature available in the LDM195 and LDM330 only.

Δ Feature found in the LDM130 and LDM330 only.

‡ Feature found in the LDM130, LDM195 and LDM330 only.







6. Battery Installation

To install batteries in the Laser Distance Meter:

1. Remove the battery cover by lifting the cover straight up from the bottom of the Laser Distance Meter as shown by the arrow in the image to the right.
2. Insert 2 “AAA” batteries into the battery compartment according to the polarity illustrated inside.
3. Replace the battery cover.



Current Battery Status

To check the current battery life, press and hold both the  and  buttons simultaneously for one second. The battery icon will display for approximately 10 seconds.

When the batteries are low, the battery icon will automatically display.



Battery has 100% power

Battery has approximately 60% power

Battery has approximately 25% power

Battery has approximately 5% power,
and new batteries are needed

Notes:

- Use only alkaline batteries.
- Remove the batteries when storing the instrument for an extended time (more than 3 months) to avoid damage to the tool should the batteries deteriorate.







7. Operating Instructions

IMPORTANT: It is the responsibility of the user to ensure proper maintenance of the Laser Distance Meter. Conduct periodic test measurements to ensure the instrument is measuring accurately and consistently. This is most important if the instrument has been exposed to extreme temperatures or moisture. Always confirm accuracy before and during important measurements. Keep the Laser Distance Meter optic lens clean and inspect for damage. The Laser Distance Meter is designed to withstand a drop from 3 feet (1 meter). If dropped from a higher distance, the tool's calibration may be affected and it should be tested for accuracy.

Power On/Off the Laser Distance Meter

Press either the  button or the  button to power on the instrument.

Press and hold the  button to power off the instrument.

Automatic Shutoff

Laser will turn off after remaining idle for 2 minutes. Press the  button to re-enable the laser.

Unit will turn off after remaining idle for 5 minutes.







Volume Control

The Laser Distance Meter has three volume settings: high, low and off. When the instrument is powered on, it will default to the most recently used volume setting.

To change the volume setting, press and hold the  button. The unit will cycle through the three settings (S1 = high, S-2 = low, Off = mute) until you release the button.

Bluetooth® Mode

When the instrument is first turned on, the Bluetooth® setting will be off. To turn it on, press and hold the  button until the Bluetooth® icon () flashes at the top of the LCD screen. To turn it off, press and hold the  button until the Bluetooth® icon disappears from the LCD screen.

Note: For more information on pairing the Laser Distance Meter with the Measure-Up™ app, see the Using the Bluetooth® App section of this manual.

Measuring Modes

The Laser Distance Meter has 4 measuring modes. When the instrument is powered on, it will default to the Length measuring mode.

1. Length (Single or Continuous)
2. Area/Square
3. Volume/Cube
4. 2-Point Pythagoras





To select a mode, press the  button. When there is no measuring mode icon shown near the top left of the LCD screen, the instrument is in the Length measuring mode. The selected measuring mode icon will display near the top left of the LCD screen for the Area, Volume, and 2-Point Pythagoras measuring modes.

No icon will display when the tool is in Length mode

Length
(single or continuous)



Area/Square



Volume/Cube





**2-Point
Pythagoras**

Units of Measure

The Laser Distance Meter has 7 units of measure.

1. Feet in decimal format (e.g., 11.48 ft)
2. Inches in decimal format (e.g., 137.83 in)
3. Feet and inches in 1/32" (e.g., 11'5" 27/32)
4. Inches in 1/32" (e.g., 137" 27/32)
5. Inches in 1/16" (e.g., 137" 7/8)
6. Inches in 1/8" (e.g., 137" 7/8)
7. Meters (e.g., 3.501 m)

To select a unit of measure before making a measurement, press the  button. The word "Unit" will appear in the center of the LCD screen, and the unit of measure will display at the bottom right of the LCD screen. Continue to press the  button to scroll through the different units of measure. **OR** after taking a measurement, press the  button to scroll through the various units of measurement.

Note: The screen will only display feet and meters in a decimal format in Area or Volume modes.



Measurement Reference Position

Note: Setting the measurement reference correctly is critical to obtaining an accurate measurement, as it establishes the place where a reading of zero (0) is located. If the wrong reference position is selected, the measurement will be off by the length of the tool (4.14 inches/ \approx 4 1/8").

The Laser Distance Meter has two reference positions for measurement, which establish the place where a reading of zero (0) is located. When the instrument is first turned on, it will default to the most recently used position.

1. Front of the unit
2. Back of the unit

To select the desired position, press the  button. The laser indicator icon at the top left of the LCD screen will display the selected position.





Front of Unit Zero
Reference Position







Back of Unit Zero
Reference Position



Length Measurement Mode – Single

1. After turning on the instrument, it will default to the Length mode. If the mode has been changed and you wish to return to the Length mode, press the  button until the measuring mode icon on the LCD screen disappears.
2. After selecting the desired unit of measure and reference position, aim the Laser Distance Meter so that the laser dot is on the selected target.
3. Keep your position stable and press the  button.
4. The measurement will appear on the main display, and the laser will turn off.
5. Press the  button again to take your next Length measurement.







Length Measurement Mode – Continuous

1. After selecting the desired unit of measure and reference position, aim the Laser Distance Meter so that the laser dot is on the selected target.
2. Keep your position stable and press and hold the  button. The Laser Distance Meter will enter continuous length measurement mode.
3. Move the instrument as necessary to the proper distance.
4. Press the  button or  button to pause the measurement. The laser will turn off.
5. To exit the continuous mode and return to the single length measurement mode, press the  button while the tool is paused.



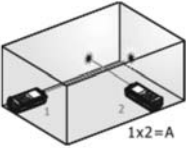







Area/Square Measurement Mode

1. Press the  button once until the Area/Square mode icon () displays near the top left of the LCD screen.
 2. After selecting the desired unit of measure and reference position, aim the Laser Distance Meter so that the laser dot is on the selected target to measure the length (indicated by a "1" in the figure to the right).
- 
3. Keep your position stable and press the  button. The length measurement will appear above the main display.
 4. Aim the Laser Distance Meter so that the laser dot is on the selected target to measure the width (indicated by a "2" in the figure to the right).
 5. Keep your position stable and press the  button again. The length and width measurements will appear on the secondary screen, and the calculated area will appear on the main screen. The laser will turn off.
 6. Press the  button again to take your next Area measurement.



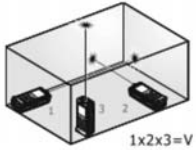

Volume/Cube Measurement Mode

1. Press the  button two times until the Volume/Cube mode icon () displays near the top left of the LCD screen.
 2. After selecting the desired unit of measure and reference position, aim the Laser Distance Meter so that the laser dot is on the selected target to measure the length (indicated by a “1” in the figure to the right).
- 
3. Keep your position stable and press the  button. The length measurement will appear above the main display.
 4. Aim the Laser Distance Meter so that the laser dot is on the selected target to measure the height.
 5. Keep your position stable and press the  button again. The length and height measurements will appear above the main screen.
 6. Aim the Laser Distance Meter so that the laser dot is on the selected target to measure the width.
 7. Keep your position stable and press the  button again. The height and width measurements will appear above the main screen, and the calculated volume will appear on the main screen. The laser will turn off.
 8. Press the  button again to take your next Volume measurement.





2-Point Pythagoras Measurement Mode

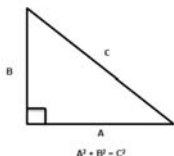

2-Point Pythagoras measurement mode refers to a measurement mode based off the Pythagorean Theorem ($A^2 + B^2 = C^2$). If you know 2 lengths (but not the third), this formula allows you to calculate a missing dimension of a triangle. The



Laser Distance Meter uses this theorem to indirectly measure lengths that are otherwise not directly measurable, enhancing the utility of the tool.



Typically, the Laser Distance Meter is used to measure a height shown above as “B” when there is no target at the top surface at which to aim the laser, such as a tall wall. The measurement can be taken by standing back at some distance “A” and taking measurements of “C” (on the side of the wall) and “A” (aimed level at the wall).

To use the 2-Point Pythagoras measurement mode:

1. Press the  button 3 times until the Pythagoras mode icon () displays near the top left of the LCD screen.
2. After selecting the desired unit of measure and reference position, aim the Laser Distance Meter so that the laser dot is on the selected target to measure the length of the hypotenuse (represented by “C” in the figure above) and indicated by the flashing lines on the LCD screen).
3. Keep your position stable and press the  button. The hypotenuse length measurement will appear above the main display.





4. Aim the Laser Distance Meter so that the laser dot is on the selected target to measure the length of the base (represented by “A” in the figure above).
5. Keep your position stable and press the  button again. The hypotenuse and base length measurements will appear above the main screen. The indirect height will appear on the main screen (represented by “B” in the figure above). The laser will turn off.
6. Press the  button again to take your next 2-Point Pythagoras measurement.

Measurement Addition and Subtraction

To add consecutive measurements, complete the following steps:

1. Complete your first measurement
2. Press the  button. The first measurement will appear above the main display.
3. Complete your second measurement. The second measurement will appear above the main display, and the sum of the two measurements will appear in the main display.
4. Repeat step 3 above as necessary to add further measurements.





To subtract consecutive measurements, complete the following steps:

1. Complete your first measurement
2. Press the  button. The first measurement will appear above the main display.
3. Complete your second measurement. The second measurement will appear above the main display, and the difference of the two measurements will appear in the main display.
4. Repeat step 3 above as necessary to subtract further measurements.

8. Using the Bluetooth® Measure-Up™ App



This LDM features Bluetooth® for integration with your Android or iOS smartphone or tablet. The app allows you to photograph and dimension your jobsite. The dimensioned drawings can be saved or exported to email or other popular messaging apps.



To get started, you'll need a device running iOS or Android. Download the free Measure-Up™ app from the App Store or the Play Store.

Power up the LDM and press and hold the Bluetooth® button  until the Bluetooth® indicator on the LDM screen flashes. Keep the LDM in length mode the entire time you use it with the app.









Ensure your smartphone or tablet's Bluetooth® is enabled, then open the Measure-Up™ app and select the Bluetooth® pairing icon . Select the laser distance meter from the list of Bluetooth® devices. You may need to hit the  refresh button in the App to see the device. The next time you pair the same LDM, you can omit this step – you will be prompted to reconnect to the last device, if it is enabled and within range.



Use the camera icon  to take a picture of your jobsite. It is recommended to hold your device in landscape mode for taking the picture because it will maximize the screen area available for dimensioning your drawing. Accept the photo, then begin adding dimension lines. Select the dimension icon  to begin drawing the dimension lines. You can draw arrows, rectangles (for area) or cubes (for volumes). You can adjust the corners of the rectangles or cubes to adjust for any perspective distortion in your photo by dragging the ends of the line segments. Select the check mark  icon to finish your dimension lines.

Next, take your measurements one at a time on the LDM. The LDM should stay in length mode, even for areas or volumes - the app will calculate these. Each measurement taken will appear on the top right of the display in the app. Click and drag the dimension in the app to the appropriate dimension line in the app to snap the dimension to the dimension line.

To append a voice, text, or video message to the picture, click the  button and select video , audio  or text .





When you have completed your image, press  to save it. To exit without saving, press . You can return to your image in the app later, or you can export it by pressing . It can be emailed, or sent via many popular messaging or storage apps.





9. Tips from the Pros

- Take more than one measurement in situations where accuracy is critical.
- Take 3-4 measurements from the same position to compare the consistency of each reading.
- To accurately measure objects lacking an inside corner from the rear of the instrument, use a scrap piece of drywall or other flat material to extend the corner. Butt the Laser Distance Meter up to the material (as shown).
- If error message “ERR 2” appears, place a white sheet of paper or reflective presse over the targeted measuring surface to improve the return signal.
- Be aware that when outdoors, the working range of the tool decreases significantly due to ambient light. The “unfavorable conditions” accuracy and distance limits shown in the specifications section quantify the performance you should expect from your laser distance meter in bright sunlight conditions.
- To make the laser beam more visible, aim it down in front of you and then follow it with your eyes as you move it towards the desired target.
- When making Pythagoras measurements, make sure that you hold the tool as flat as possible during your second measurement for the most accurate measurements. The beam should hit perpendicular to the object you are measuring.





10. Care and Handling

- This Laser Distance Meter unit is a precision tool that must be handled with care.
- Avoid exposing unit to shock vibrations and extreme temperatures.
- Remove the batteries when storing the unit for an extended time (more than 3 months) to avoid damage to the unit should the batteries deteriorate.
- Avoid getting the unit wet.
- Keep the laser unit dry and clean, especially the laser output window. Remove any moisture or dirt with a soft, dry cloth.
- Do not use harsh chemicals, strong detergents or cleaning solvents to clean the unit.





11. Troubleshooting Guide

This section is designed to help you diagnose and troubleshoot common problems that prevent the Laser Distance Meter from working properly.

If the Laser Distance Meter returns an ERR code (display shows ERR plus a number from 1 to 6), please *refer to Section 4* of this manual for possible resolutions. If your Laser Distance Meter fails to operate in any other way, please refer to the following troubleshooting guide for some suggestions on how to diagnose the problem.

Symptom	Possible Cause	Solution
Will not turn on	Batteries missing or depleted	Change the batteries
	Polarity reversed	Check battery polarity
Turns off after a short time	Batteries depleted	Change the batteries
Measurement seems incorrect	Incorrect reference position used	Set the reference position to the front rear edge of the tool, as appropriate





12. Technical Specifications

Laser Wavelength	650 nm
Laser Classification	II
Maximum Power Output	≤ 1 mW
Typical Accuracy*	$\pm 1/16''$ over the full working range
Accuracy at Unfavorable Conditions**	$\pm 3/16''$ over the full working range
Typical Measuring Range*	2'' - 130'
Typical Interior Range*	2'' - 130'
Range at Unfavorable Conditions**	2'' - 45'
Operating Modes	Length (Single or Continuous), Area, Volume, 2-Point Pythagoras
Units	ft, in, m, 1/8", 1/16", 1/32"
Bluetooth®	Yes
Angle Sensor	No
Power Supply	2 "AAA" alkaline batteries (included)
Battery Life	Minimum 10 hours/10,000 measurements
Operating Temperature Range	23°F - 104°F
Storage Temperature Range	-4°F - 160°F
Dimensions	4.1"x1.9"x0.8"
Weight	3 oz. including batteries; 2.25 oz. excluding batteries
IP Rating	IP 54



*Tested per ISO 16331-1.

**Per ISO16331-1, unfavorable conditions are designed to simulate bright sunlight and give an approximate indication of the working range of the tool outdoors on a bright, sunny day. Overcast or darker days will offer a longer working range.

13. Product Warranty

Johnson Level & Tool offers a two year limited warranty on each of its products. You can obtain a copy of the limited warranty for a Johnson Level & Tool product by contacting Johnson Level & Tool's Customer Service Department, as provided below, or by visiting our web site at www.johnsonlevel.com. The limited warranty for each product contains various limitations and exclusions.

Do not return this product to the store/retailer or place of purchase.

Non-warranty repairs and course calibration must be done by an authorized Johnson® service center or Johnson Level & Tool's limited warranty, if applicable, will be void and there will be NO WARRANTY. Contact one of our service centers for all non-warranty repairs. A list of service centers can be found on our web site at www.johnsonlevel.com or by calling our Customer Service Department. Contact our Customer Service Department for Return Material Authorization (RMA) for warranty repairs (manufacturing defects only). Proof of purchase is required.

NOTE: The user is responsible for the proper use and care of the product. It is the responsibility of the user to verify the calibration of the instrument before each use.

For further assistance, or if you experience problems with this product that are not addressed in this instruction manual, please contact our Customer Service Dept.

In the U.S., contact Johnson Level & Tool's Customer Service Department at 888-9-LEVELS.

In Canada, contact Johnson Level & Tool's Customer Service Department at 800-346-6682.



14. Warranty Registration

Please register within 30 days of purchase. Registering ensures we have your information on file for warranty service even if you lose your receipt, and lets us contact you if there is ever a product recall. We will never sell your information and only send you marketing information if you opt-in.

To register, go to www.johnsonlevel.com/register.



15. Accessories

Johnson® accessories are available for purchase through authorized Johnson® dealers. Use of non-Johnson® accessories will void any applicable limited warranty and there will be NO WARRANTY. If you need any assistance in locating any accessories, please contact our Customer Service Department.

In the U.S., contact Johnson Level & Tool's Customer Service Department at 888-9-LEVELS.

In Canada, contact Johnson Level & Tool's Customer Service Department at 800-346-6682.

